



TRB142

Quick Start Guide v2.3



Wiki knowledge base
<https://wiki.teltonika.lt/>



FRONT VIEW

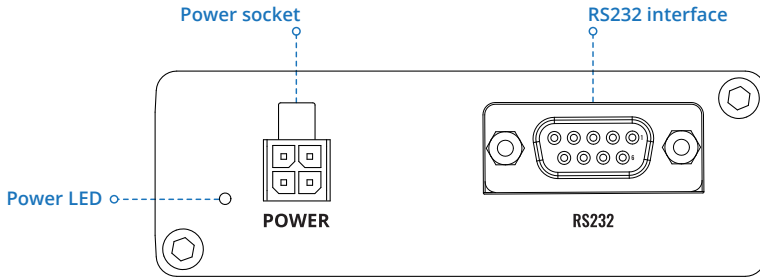

BACK VIEW

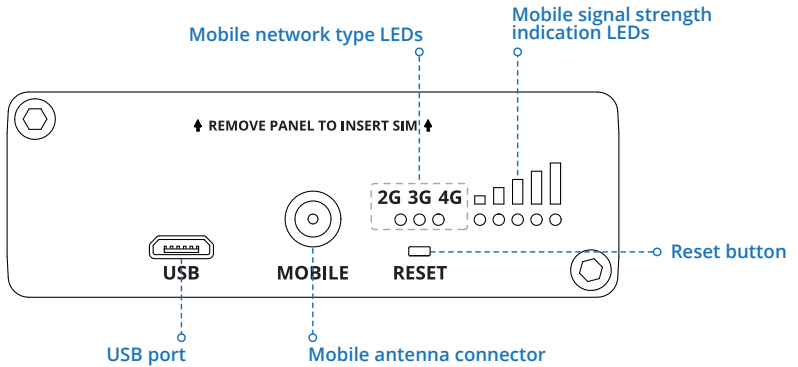

DB9 CONNECTOR PINOUT

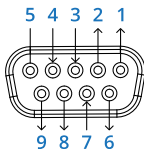

POWER SOCKET PINOUT

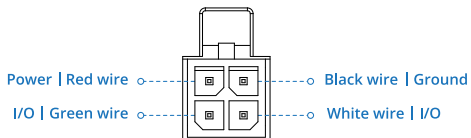

HARDWARE INSTALLATION

1. Unscrew two back panel hex bolts.
2. Remove the back panel.
3. Insert your SIM card into the SIM socket.
4. Attach the panel and tighten the hex bolts.
5. Attach the LTE antenna (max torque 0.4 N·m / 3.5 lbf·in) and connect the USB cable.
6. After logging in observe the Signal Strength indication displayed in the Mobile widget (image B).

1. Not used.
2. Received Data (RX) – output.
3. Transmitted data (TX) – input.
4. Not used.
5. Ground (GND).
6. Not used.
7. Request data to send (RTS) – input.
8. Clear data to send (CTS) – output.
9. Not used.

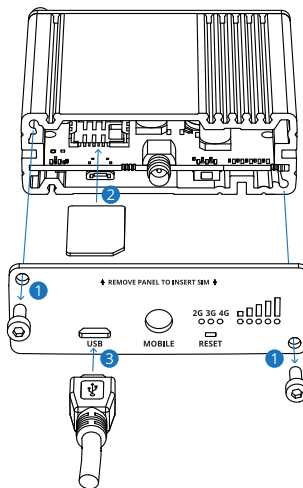

DEVICE CONFIGURATION

1. Power on the device and connect the USB cable to your computer.
2. Allow the gateway to boot up. This might take up to 30 seconds.
3. Your computer's OS should detect the USB device and install the drivers for the virtual NDIS network adapter. The IP address is set automatically via DHCP.
4. Use a Web browser to go to address <http://192.168.2.1>
5. Use login information shown in image A when prompted for authentication.
6. After logging in pay attention to the Signal Strength indication displayed in the Mobile widget (image B). To maximize the cellular performance try adjusting the antennas or changing the location of your device to achieve the best signal conditions.

A.

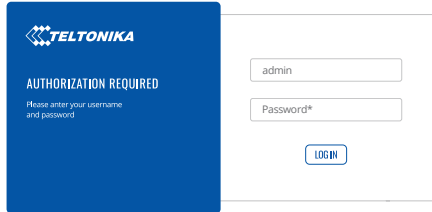

B.

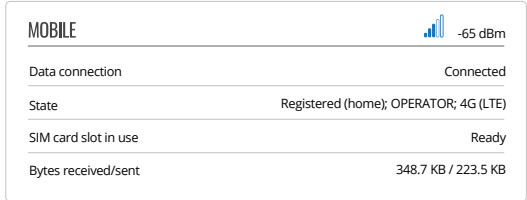

MOBILE	-65 dBm
Data connection	Connected
State	Registered (home); OPERATOR; 4G (LTE)
SIM card slot in use	Ready
Bytes received/sent	348.7 KB / 223.5 KB

TECHNICAL INFORMATION

Radio specifications	
RF technologies	GSM, GPRS, EDGE, UMTS/HSPA+, LTE
Max RF power	33 dBm@GSM, 24 dBm@WCDMA, 23 dBm@LTE
Bundled accessories information*	
Power	AC/DC power adapter 9 V, 0.5 A, 4 pin plug
GSM/WCDMA/LTE antenna	698-868/1850-2690 MHz, 50 Ω, VSWR < 2, gain** 2 dBi, omnidirectional, SMA male connector

*Order code dependent.

**Higher gain antenna can be connected to compensate for cable attenuation when a cable is used. The user is responsible for the compliance with the legal regulations.

SAFETY INFORMATION

TRB142 gateway must be used in compliance with any and all applicable national and international laws and with any special restrictions regulating the utilization of the communication module in prescribed applications and environments.

[EN] English	Hereby, TELTONIKA declares that this TRB142 is in compliance with the essential requirements and other relevant provisions of Directive RED.
[BG] Bulgarian	С настоящето, TELTONIKA декларира, че TRB142 е в съответствие със съществените изисквания и другите приложими разпоредби на Директива RED.
[CZ] Czech	TELTONIKA tímto prohlašuje, že TRB142 splňuje základní požadavky a všechna příslušná ustanovení Směrnice RED.
[DE] German	Hiermit erklärt TELTONIKA dass sich das Gerät TRB142 in Übereinstimmung mit den grundlegenden Anforderungen und den übrigen einschlägigen Bestimmungen der Richtlinie RED befindet.
[DK] Danish	Undertegnede TELTONIKA erklærer herved, at følgende udstyr TRB142 overholder de væsentlige krav og øvrige relevante krav i direktiv RED.
[EE] Estonian	Käesolevaga kinnitab TELTONIKA seadme TRB142 vastavust direktiivi RED põhinõuetele ja nimetatud direktiivist tulenevatele teistele asjakohastele sätetele.
[ES] Spanish	Por la presente, TELTONIKA declara que este TRB142 cumple con los requisitos esenciales y otras exigencias relevantes de la Directiva RED.
[FI] Finnish	TELTONIKA vakuuttaa täten että TRB142 tyypin laite on direktiivin RED oleellisten vaatimusten ja sitä koskevien direktiivin muiden ehtojen mukainen.
[FR] French	TELTONIKA déclare que cette TRB142 est conforme aux exigences essentielles et aux autres dispositions pertinentes de la directive RED.
[GR] Greek	ΜΕ ΤΗΝ ΠΑΡΟΥΣΑ Ο ΚΑΤΑΣΚΕΥΑΣΤΗΣ ΤΕΛΤΟΝΙΚΑ ΔΗΛΩΝΕΙ ΟΤΙ ΤΗΡΒ142 ΣΥΜΜΟΡΦΩΝΕΤΑΙ ΠΡΟΣ ΤΙΣ ΟΥΣΙΩΔΕΙΣ ΑΠΑΙΤΗΣΕΙΣ ΚΑΙ ΤΙΣ ΛΟΙΠΕΣ ΣΧΕΤΙΚΕΣ ΔΙΑΤΑΞΕΙΣ ΤΗΣ ΟΔΗΓΙΑΣ RED.
[HU] Hungarian	A TELTONIKA ezennel kijelenti, hogy a TRB142 típusú berendezés teljesíti az alapvető követelményeket és más RED irányelvben meghatározott vonatkozó rendelkezéseket.
[IT] Italian	Con la presente TELTONIKA dichiara che questo TRB142 è conforme ai requisiti essenziali ed alle altre disposizioni pertinenti stabilite dalla direttiva RED.
[LT] Lithuanian	Šiuo dokumentu UAB TELTONIKA deklaruoja, kad šis TRB142 atitinka esminius reikalavimus ir kitas RED Direktyvos nuostatas.
[LV] Latvian	Ar šo TELTONIKA deklarē, ka TRB142 atbilst Direktīvas RED būtiskajām prasībām un citiem ar to saistītajiem noteikumiem.
[NL] Dutch	Hierbij verklaart TELTONIKA dat het toestel I TRB142 in overeenstemming is met de essentiële eisen en de andere relevante bepalingen van richtlijn RED.
[NO] Norwegian	TELTONIKA Erklærer herved at TRB142 er i samsvar med de grunnleggende krav og øvrige relevante krav i direktiv RED.
[PL] Polish	Niniejszym TELTONIKA deklaruje że TRB142 jest zgodny z zasadniczymi wymaganiami i innymi właściwymi postanowieniami Dyrektywy RED.
[PT] Portuguese	Eu, TELTONIKA declaro que o TRB142 cumpre os requisitos essenciais e outras provisões relevantes da Directiva RED.
[RO] Romanian	Prin prezenta, TELTONIKA declară că aparatul TRB142 este în conformitate cu cerințele esențiale și cu alte prevederi pertinente ale Directivei RED.
[SE] Swedish	Härmed intygar TELTONIKA att denna TRB142 är i överensstämmelse med de väsentliga egenskapskrav och övriga relevanta bestämmelser som framgår av direktiv RED.
[SI] Slovenian	TELTONIKA izjavlja, da je ta TRB142 v skladu z bistvenimi zahtevami in drugimi relevantnimi določili direktive RED.

The full text of the EU declaration of conformity is available at the following internet address: https://wiki.teltonika.lt/view/TRB142_CE/RED

- [EN]** Instruction Manual: Connect the power adapter to turn on the device. Open 192.168.2.1 in your web browser to configure it. More information on <https://wiki.teltonika.lt>
- [BG]** Инструкция: Свържете адаптера за захранване, за да включите устройството. Отворете 192.168.2.1 в уеб браузър, за да настроите продукта. Повече информация в <https://wiki.teltonika.lt>
- [CZ]** Návod k použití: Připojte napájecí adaptér k zapnutí přístroje. Otevřete 192.168.2.1 ve webovém prohlížeči pro konfiguraci produktu. Více informací najdete v <https://wiki.teltonika.lt>
- [DE]** Bedienungsanleitung: Verbinden Sie das Netzteil, um das Gerät einzuschalten. Öffnen Sie 192.168.2.1 in einem Web Browser, um das Produkt zu konfigurieren. Weitere Informationen im <https://wiki.teltonika.lt>
- [DK]** Instruktionsbog: Tilslut strømadapteren for at tænde for enheden. Åbn 192.168.2.1 i en webbrowser til at konfigurere produktet. Mere information i <https://wiki.teltonika.lt>
- [EE]** Kasutusjuhend: Ühendage toiteadapter seadme sisselülitamiseks. Avatud 192.168.2.1 in veebilehitseja seadistada toodet. Rohkem teavet <https://wiki.teltonika.lt>
- [ES]** Manual de instrucciones: Conecte el adaptador de alimentación para encender la unidad. Abra 192.168.2.1 en un navegador web para configurar el producto. Más información en <https://wiki.teltonika.lt>
- [FI]** Käyttöohje: Kytke virtalähde päälle laitteeseen. Avaa 192.168.2.1 in selaimen määräättää tuotteen. Lisää tietoa <https://wiki.teltonika.lt>
- [FR]** Mode d'emploi: Connectez l'adaptateur d'alimentation pour allumer l'appareil. Ouvrez 192.168.2.1 dans un navigateur Web pour configurer le produit. Plus d'informations dans <https://wiki.teltonika.lt>
- [GR]** εγχειρίδιο οδηγιών: Συνδέστε τον προσαρμογέα τροφοδοσίας για να ενεργοποιήσετε τη μονάδα. Ανοίξτε 192.168.2.1 σε ένα πρόγραμμα περιήγησης στο Web για να διαμορφώσετε το προϊόν. Περισσότερες πληροφορίες στο <https://wiki.teltonika.lt>
- [HU]** Használati utasítás: Csatlakoztassa a hálózati adaptert a készülék bekapcsolásához. Megnyitása 192.168.2.1 egy webböngészőben beállítani a terméket. Több információ <https://wiki.teltonika.lt>
- [IT]** Manuale di istruzioni: Collegare l'adattatore di alimentazione per accendere l'unità. Aprire 192.168.2.1 in un browser Web per configurare il prodotto. Maggiori informazioni in <https://wiki.teltonika.lt>
- [LT]** Naudojimosi instrukcija: Prijunkite maitinimo adapterį, įjunkite įrenginį. Internete naršykite atidarykite adresą 192.168.2.1 - galite konfiguruoti gaminį. Daugiau informacijos rasite <https://wiki.teltonika.lt>
- [LV]** Lietošanas instrukcija: Pievienojiet Strāvas adapteri, lai ieslēgtu ierīci. Atvērt 192.168.2.1 ar interneta pārlūku, lai konfigurētu produktu. Plašāka informācija <https://wiki.teltonika.lt>
- [NL]** Handleiding: Sluit voedingsadapter aan op het apparaat in te schakelen. Open 192.168.2.1 in een webbrowser om het product te configureren. Meer informatie in <https://wiki.teltonika.lt>
- [NO]** Bruksanvisningen: Koble strømadapteren for å slå på enheten. Åpne 192.168.2.1 i en nettleser for å konfigurere produktet. Mer informasjon på <https://wiki.teltonika.lt>
- [PL]** Instrukcja obsługi: Podłącz adapter zasilania, aby włączyć urządzenie. Otwórz 192.168.2.1 w przeglądarce internetowej, aby skonfigurować urządzenie. Więcej informacji w <https://wiki.teltonika.lt>
- [PT]** Manual de instruções: Conecte o adaptador de alimentação para ligar o aparelho. Abra 192.168.2.1 em um navegador da web para configurar o produto. Mais informações em <https://wiki.teltonika.lt>
- [RO]** Instrucțiuni de utilizare: Conectați adaptorul de alimentare pentru a porni aparatul. Deschide 192.168.2.1 întrun browser web pentru a configura produsul. Mai multe informații în <https://wiki.teltonika.lt>
- [SE]** Instruktionsmanual: Anslut nätadap tern för att slå på enheten. Öppna 192.168.2.1 i en webbläsare för att konfigurera produkten. Mer information på <https://wiki.teltonika.lt>
- [SI]** Navodila: Priključite napajalnik za vklop naprave. Odprite 192.168.2.1 v spletnem brskalniku nastaviti izdelek. Več informacij v <https://wiki.teltonika.lt>
- [SK]** Návod na použitie: Pripojte napájací adaptér k zapnutiu prístroja. Otvorte 192.168.2.1 vo webovom prehliadači pre konfiguráciu produktu. Viac informácií nájdete v <https://wiki.teltonika.lt>

For more information visit www.teltonika-networks.com



This sign means that all used electronic and electric equipment should not be mixed with general household waste.



This sign means that product meets the requirements of the applicable EU directives.